

## DESCRIPTION

The MP2494 is a monolithic step-down switch mode converter. It achieves 2A continuous output current over a wide input supply range with excellent load and line regulation.

MP2494 achieves low EMI signature with well controlled switching edges.

Fault condition protection includes cycle-by-cycle current limiting and thermal shutdown.

The MP2494 requires a minimum number of readily available standard external components. The MP2494 is available in SOIC8 and SOIC8E package.

## FEATURES

- Wide 4.5V to 55V Operating Input Range
- Output Adjustable from 0.8V to 45V
- 0.25Ω Internal Power MOSFET Switch
- Stable with Low ESR Output Ceramic Capacitors
- Fixed 100kHz Frequency
- Low EMI signature
- Thermal Shutdown
- Cycle-by-Cycle Over Current Protection
- Available in SOIC8 and SOIC8E packages

## APPLICATIONS

- USB Power Supplies
- Automotive Cigarette Lighter Adapters

All MPS parts are lead-free, halogen free, and adhere to the RoHS directive. For MPS green status, please visit MPS website under Quality Assurance. "MPS" and "The Future of Analog IC Technology" are Registered Trademarks of Monolithic Power Systems, Inc.

## TYPICAL APPLICATION

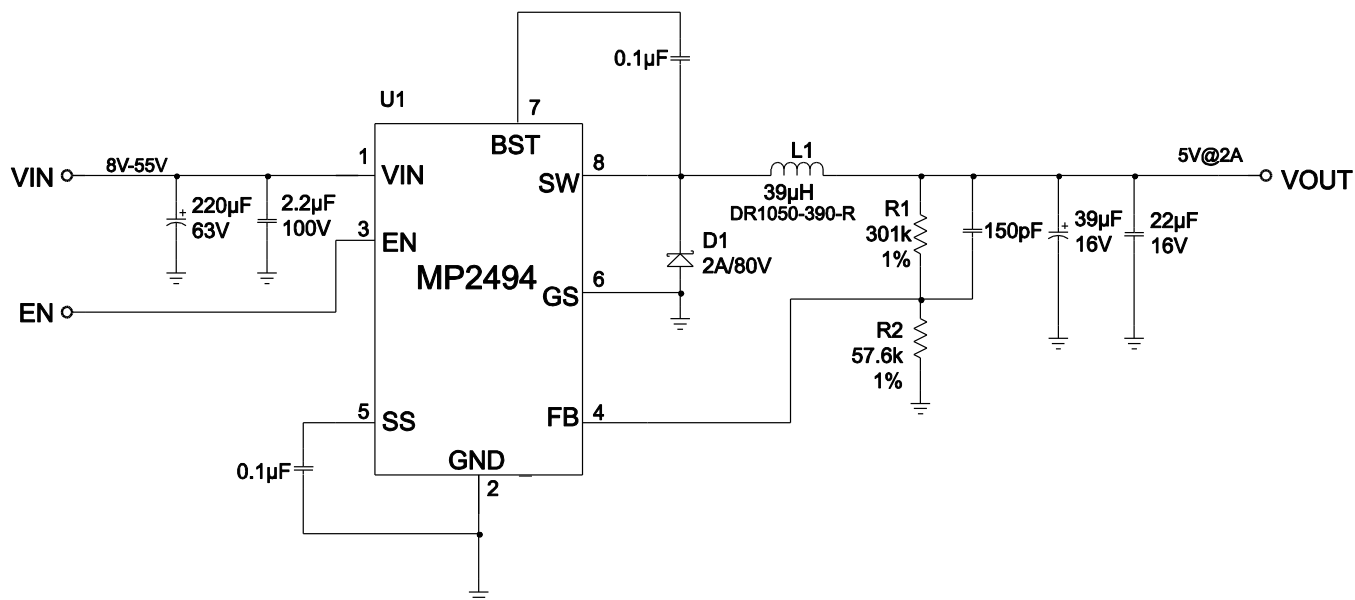

### ORDERING INFORMATION

Part Number	Package	Top Marking
MP2494DS*	SOIC8	MP2494DS
MP2494DN**	SOIC8E	MP2494DN

\* For Tape & Reel, add suffix –Z (e.g. MP2494DS–Z);  
For RoHS, compliant packaging, add suffix –LF (e.g. MP2494DS–LF–Z).

\*\* For Tape & Reel, add suffix –Z (e.g. MP2494DN–Z);  
For RoHS, compliant packaging, add suffix –LF (e.g. MP2494DN–LF–Z).

### PACKAGE REFERENCE

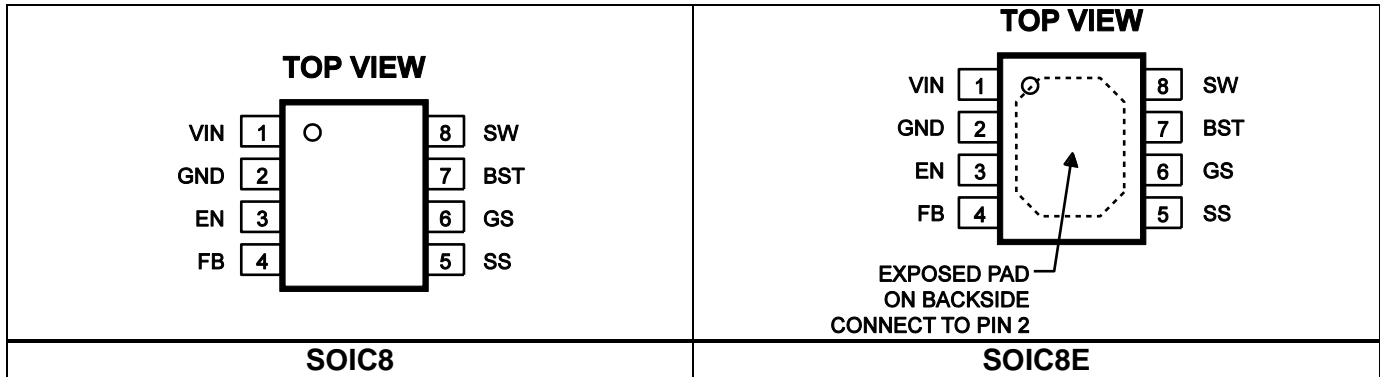

#### Absolute Maximum Ratings <sup>(1)</sup>

Input Voltage $V_{IN}$ .....	60V
$V_{SW}$ .....	–0.3V to $V_{IN} + 0.3V$
$V_{BST}$ .....	$V_{SW} + 6.5V$
All Other Pins.....	–0.3V to +6.5V
Junction Temperature .....	150°C
Lead Temperature .....	260°C
Storage Temperature.....	–65°C to +150°C
Continuous Power Dissipation ( $T_A = +25^\circ C$ ) <sup>(2)</sup>	
SOIC8.....	1.38W
SOIC8E .....	2.5W

#### Recommended Operating Conditions <sup>(3)</sup>

Input Voltage $V_{IN}$ .....	4.5V to 55V
Output Voltage $V_{OUT}$ .....	0.8V to 45V
Operating Junction Temp. ( $T_J$ ). .....	–40°C to +125°C

#### Thermal Resistance <sup>(4)</sup>

	$\theta_{JA}$	$\theta_{JC}$
SOIC8 .....	90 .....	45... °C/W
SOIC8E .....	50 .....	10... °C/W

#### Notes:

- Exceeding these ratings may damage the device.
- The maximum allowable power dissipation is a function of the maximum junction temperature  $T_J$  (MAX), the junction-to-ambient thermal resistance  $\theta_{JA}$ , and the ambient temperature  $T_A$ . The maximum allowable continuous power dissipation at any ambient temperature is calculated by  $P_D$  (MAX) =  $(T_J$  (MAX)– $T_A$ )/ $\theta_{JA}$ . Exceeding the maximum allowable power dissipation will cause excessive die temperature, and the regulator will go into thermal shutdown. Internal thermal shutdown circuitry protects the device from permanent damage.
- The device is not guaranteed to function outside of its operating conditions.
- Measured on JESD51-7, 4-layer PCB.

**ELECTRICAL CHARACTERISTICS <sup>(5)</sup>**
 **$V_{IN} = 12V$ ,  $T_A = +25^{\circ}C$ , unless otherwise noted.**

Parameters	Symbol	Condition	Min	Typ	Max	Units
Feedback Voltage	$V_{FB}$	$4.5V \leq V_{IN} \leq 55V$	0.78	0.8	0.82	V
Feedback Bias Current	$I_{BIAS(FB)}$	$V_{FB} = 0.8V$		10		nA
Switch On Resistance	$R_{DS(ON)}$			0.25		$\Omega$
Switch Leakage		$V_{EN} = 0V$ , $V_{SW} = 0V$		0.1	10	$\mu A$
Current Limit <sup>(5)</sup>				3.5		A
Oscillator Frequency	$f_{SW}$	$V_{FB} = 0.6V$	80	100	120	kHz
Boot-Strap Voltage	$V_{BST} - V_{SW}$			4.3		V
Minimum On Time <sup>(5)</sup>	$t_{ON}$	$V_{FB} = 1V$		100		ns
SW rising edge	trise	$V_{IN} = 12V$ , $V_{OUT} = 5V$ , $I_{OUT} = 2A$		50		ns
SW falling edge	tfall	$V_{IN} = 12V$ , $V_{OUT} = 5V$ , $I_{OUT} = 2A$		50		ns
EN Input Low Voltage					0.4	V
EN Input High Voltage			1.8			V
EN Input Bias Current		$V_{EN} = 0-6V$	-10	-2	10	$\mu A$
Under Voltage Lockout Threshold Rising			3.0	3.3	3.6	V
Under Voltage Lockout Threshold Hysteresis				200		mV
Supply Current (Shutdown)		$V_{EN} = 0V$		4	10	$\mu A$
Supply Current (Quiescent)		$V_{EN} = 2V$ , $V_{FB} = 1V$		500	800	$\mu A$
Thermal Shutdown <sup>(5)</sup>				150		$^{\circ}C$

**Notes:**

5) Guaranteed by design

**PIN FUNCTIONS**

Package Pin #	Name	Description
1	VIN	Supply Voltage. The MP2494 operates from a +4.5V to +55V unregulated input. CIN is needed to prevent large voltage spikes from appearing at the input. Put CIN as close to the IC as possible. It is the drain of the internal power device and power supply for the whole chip.
2	GND	Ground. This pin is the voltage reference for the regulated output voltage. For this reason care must be taken in its layout. This node should be placed outside of the D1 to CIN ground path to prevent switching current spikes from inducing voltage noise into the part.
3	EN	On/Off Control Input.
4	FB	An external resistor divider from the output to GND tapped to the FB pin sets the output voltage. It is pulled up to 4V power supply internally by a 2Meg resistor.
5	SS	Connect to an external capacitor used for Soft-Start.
6	GS	Ground Sense Input. Connect to ground.
7	BST	Bootstrap. This capacitor is needed to drive the power switch's gate above the supply voltage. It is connected between SW and BST pins to form a floating supply across the power switch driver. An on-chip regulator is used to charge up the external boot-strap capacitor. If the on-chip regulator is not strong enough, one optional diode can be connected from IN or OUT to charge the external boot-strap capacitor.
8	SW	Switch Output. It is the source of power device.

## TYPICAL PERFORMANCE CHARACTERISTICS

$C_1 = 220\mu\text{F}$ ,  $C_2 = 2.2\mu\text{F}$ ,  $C_3 = 39\mu\text{F}$ ,  $C_4 = 22\mu\text{F}$ ,  $L = 39\mu\text{H}$ ,  $T_A = 25^\circ\text{C}$ , unless otherwise noted.

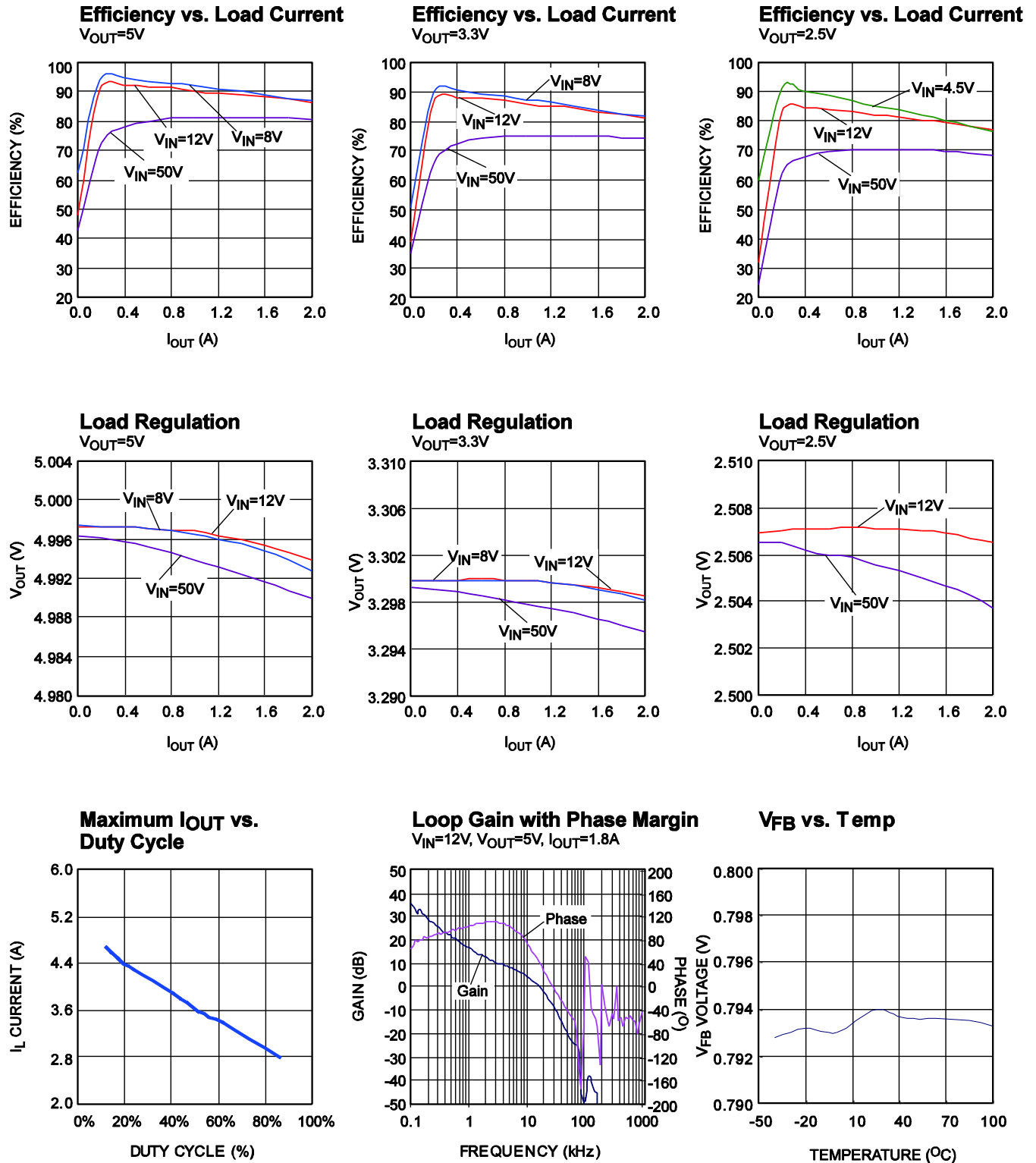

**TYPICAL PERFORMANCE CHARACTERISTICS** *(continued)*
 $C_1 = 220\mu\text{F}$ ,  $C_2 = 2.2\mu\text{F}$ ,  $C_3 = 39\mu\text{F}$ ,  $C_4 = 22\mu\text{F}$ ,  $L = 39\mu\text{H}$ ,  $T_A = 25^\circ\text{C}$ , unless otherwise noted.

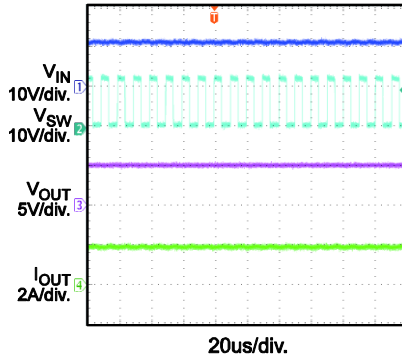
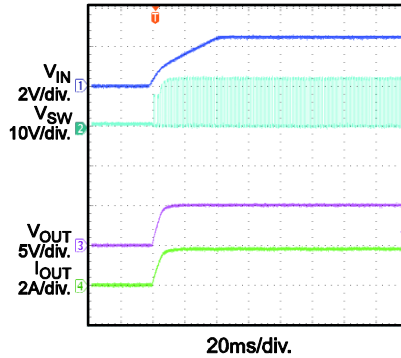
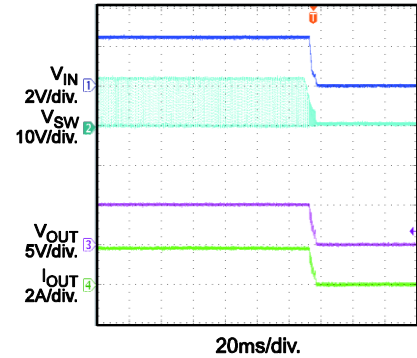
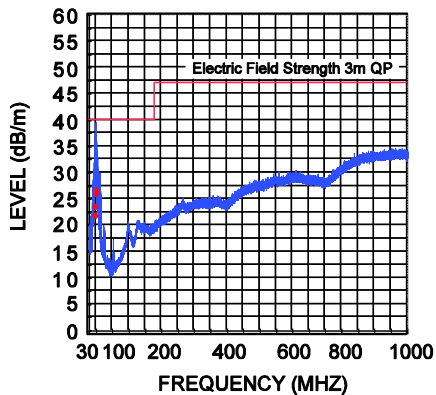
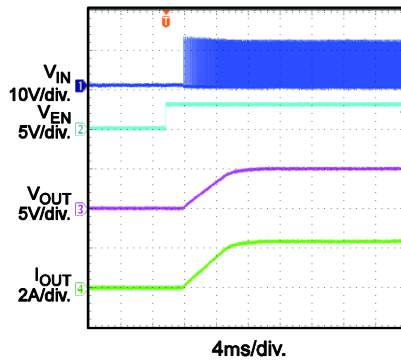
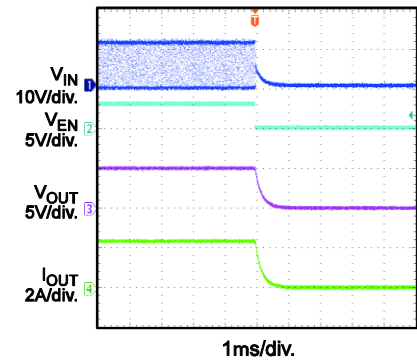
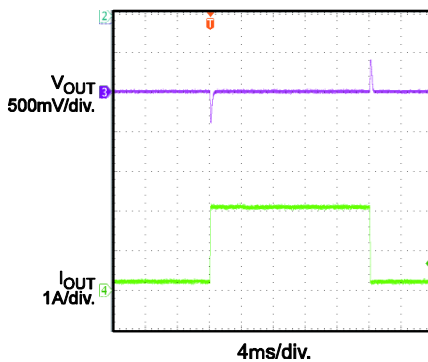
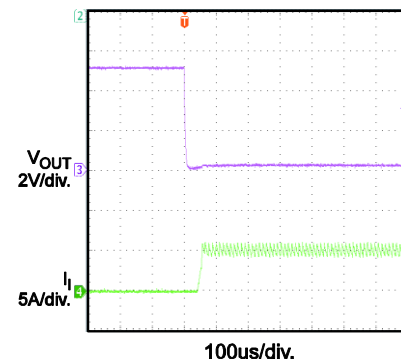
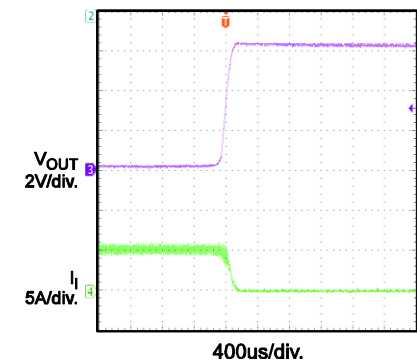
**Steady State**
 $V_{IN} = 12\text{V}$ ,  $V_{OUT} = 5\text{V}$ ,  $I_{OUT} = 2\text{A}$ ,  
Electrical Load

**Power Ramp Up**
 $V_{IN} = 12\text{V}$ ,  $V_{OUT} = 5\text{V}$ ,  $I_{OUT} = 2\text{A}$ ,  
Resistor Load

**Power Ramp Down**
 $V_{IN} = 12\text{V}$ ,  $V_{OUT} = 5\text{V}$ ,  $I_{OUT} = 2\text{A}$ ,  
Resistor Load

**EMI Radiation**
 $V_{IN} = 12\text{V}$ ,  $V_{OUT} = 5\text{V}$ ,  $I_{OUT} = 1.5\text{A}$ ,  
Resistor Load

**Enable On**

**Enable Off**

**Load Transient Response**
 $V_{IN} = 12\text{V}$ ,  $V_{OUT} = 5\text{V}$ ,  $I_{OUT} = 0.1\text{A}$  to  $2\text{A}$ ,  
Electrical Load

**Short Circuit**
 $V_{IN} = 12\text{V}$ ,  $V_{OUT} = 5\text{V}$ 

**Short Circuit Recovery**
 $V_{IN} = 12\text{V}$ ,  $V_{OUT} = 5\text{V}$ 

## OPERATION

### Main Control Loop

The MP2494 is a current mode buck regulator. That is, the EA output voltage is proportional to the peak inductor current.

At the beginning of a cycle SW is off; the EA output voltage is higher than the current sense amplifier output; and the current comparator's output is low. The rising edge of the 100kHz CLK signal sets the RS Flip-Flop. Its output turns on SW thus connecting the SW pin and inductor to the input supply.

The increasing inductor current is sensed and amplified by the Current Sense Amplifier. Ramp compensation is summed to Current Sense Amplifier output and compared to the Error Amplifier output by the Current Comparator. When the Current Sense Amplifier plus Slope Compensation signal exceeds the EA output voltage, the RS Flip-Flop is reset and the MP2494 reverts to its initial SW off state.

If the Current Sense Amplifier plus Slope Compensation signal does not exceed the COMP voltage, then the falling edge of the CLK resets the Flip-Flop.

The output of the Error Amplifier integrates the voltage difference between the feedback and the 0.8V bandgap reference. The polarity is such that an FB pin voltage lower than 0.8V increases the EA output voltage. Since the EA output voltage is proportional to the peak inductor current, an increase in its voltage increases current delivered to the output. An external Schottky Diode (D1) carries the inductor current when SW is off.

### Enable Control

The MP2494 has an Enable control pin (EN). Drive EN above 1.8V to turn on the MP2494. Drive EN below 0.4V to turn it off. Tie EN to VIN for automatic start up.

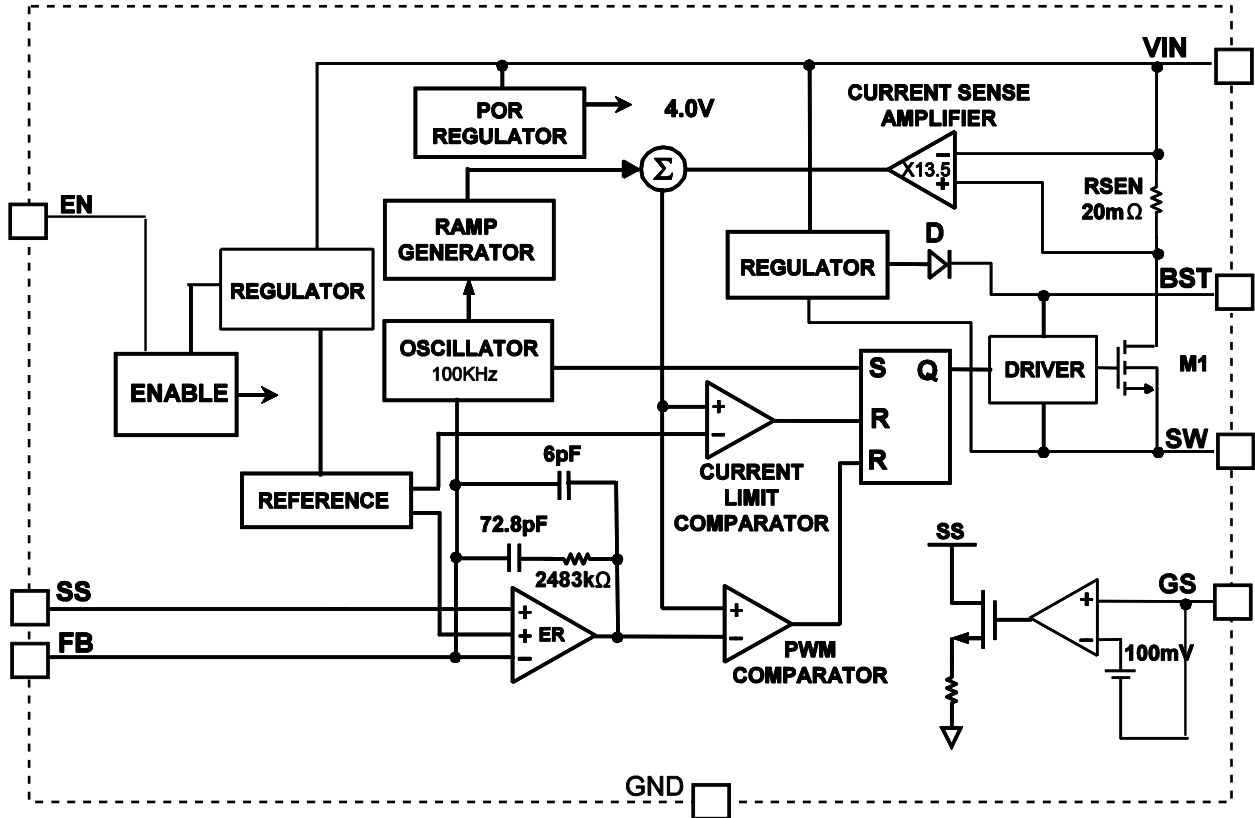

Figure 1—Function Block Diagram



## APPLICATION INFORMATION

### Setting the Output Voltage

The external resistor divider is used to set the output voltage (see the schematic on front page). The feedback resistor R1 also sets the feedback loop bandwidth with the internal compensation capacitor (see Figure 1). Choose R1 to be around 300kΩ for optimal transient response. R2 is then given by:

$$R2 = \frac{R1}{\frac{V_{OUT}}{0.8V} - 1}$$

**Table 1—Resistor Selection for Common Output Voltages**

V <sub>OUT</sub> (V)	R1 (kΩ)	R2 (kΩ)
1.8	300 (1%)	240 (1%)
2.5	300 (1%)	141.1 (1%)
3.3	300 (1%)	96 (1%)
5	300 (1%)	57.1 (1%)

### Selecting the Inductor

A 33μH to 47μH inductor with a DC current rating of at least 25% percent higher than the maximum load current is recommended for most applications. For highest efficiency, the inductor DC resistance should be less than 200mΩ. For most designs, the inductance value can be derived from the following equation.

$$L = \frac{V_{OUT} \times (V_{IN} - V_{OUT})}{V_{IN} \times \Delta I_L \times f_{OSC}}$$

Where ΔI<sub>L</sub> is the inductor ripple current.

Choose inductor current ripple to be approximately 30% of the maximum load current, 2A. The maximum inductor peak current is:

$$I_{L(MAX)} = I_{LOAD} + \frac{\Delta I_L}{2}$$

Under light load conditions below 100mA, larger inductance is recommended for improved efficiency.

### Selecting the Input Capacitor

The input capacitor reduces the surge current drawn from the input and also the switching noise from the device. The input capacitor impedance at the switching frequency should be less than the input source impedance to prevent high frequency switching current from pass to the input. Ceramic capacitors with X5R or X7R dielectrics are highly recommended because of their low ESR and small temperature coefficients. For most applications, a 4.7μF capacitor is sufficient.

### Selecting the Output Capacitor

The output capacitor keeps output voltage small and ensures regulation loop stability. The output capacitor impedance should be low at the switching frequency. Ceramic capacitors with X5R or X7R dielectrics are recommended.

### PC Board Layout

The high current paths (GND, IN and SW) should be placed very close to the device with short, direct and wide traces. The input capacitor needs to be as close as possible to the IN and GND pins. The external feedback resistors should be placed next to the FB pin. Keep the switching node SW short and away from the feedback network.

### External Bootstrap Diode

It is recommended that an external bootstrap diode be added when the system has a 5V fixed input or the power supply generates a 5V output. This helps improve the efficiency of the regulator. The bootstrap diode can be a low cost one such as IN4148 or BAT54.

This diode is also recommended for high duty cycle operation (when  $\frac{V_{OUT}}{V_{IN}} > 65\%$ ) and high output voltage (V<sub>OUT</sub>>12V) applications.

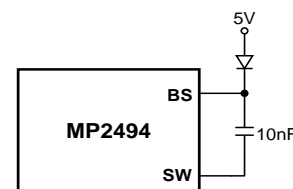

**Figure 2—External Bootstrap Diode**

## PACKAGE INFORMATION

## SOIC8E

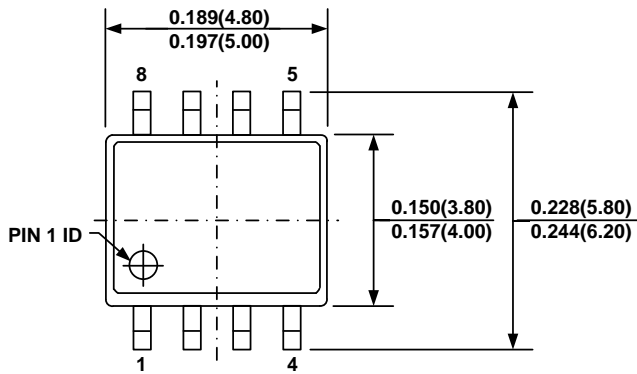

TOP VIEW

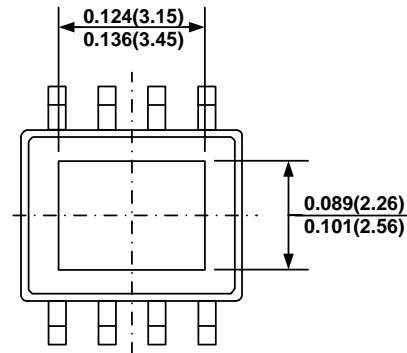

BOTTOM VIEW

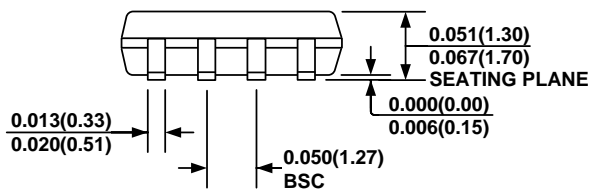

FRONT VIEW

SEE DETAIL "A"

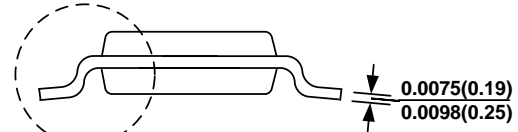

SIDE VIEW

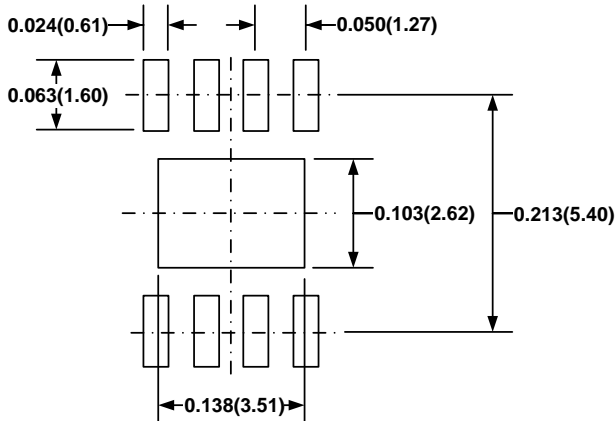

RECOMMENDED LAND PATTERN

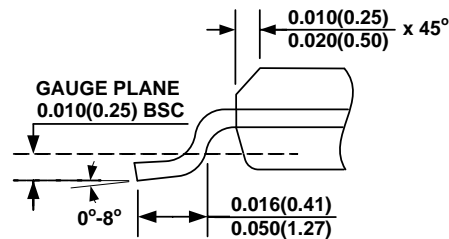

DETAIL "A"

## NOTE:

- 1) CONTROL DIMENSION IS IN INCHES. DIMENSION IN BRACKET IS IN MILLIMETERS.
- 2) PACKAGE LENGTH DOES NOT INCLUDE MOLD FLASH, PROTRUSIONS OR GATE BURRS.
- 3) PACKAGE WIDTH DOES NOT INCLUDE INTERLEAD FLASH OR PROTRUSIONS.
- 4) LEAD COPLANARITY (BOTTOM OF LEADS AFTER FORMING) SHALL BE 0.004" INCHES MAX.
- 5) DRAWING CONFORMS TO JEDEC MS-012, VARIATION BA.
- 6) DRAWING IS NOT TO SCALE.

## PACKAGE INFORMATION

### SOIC8

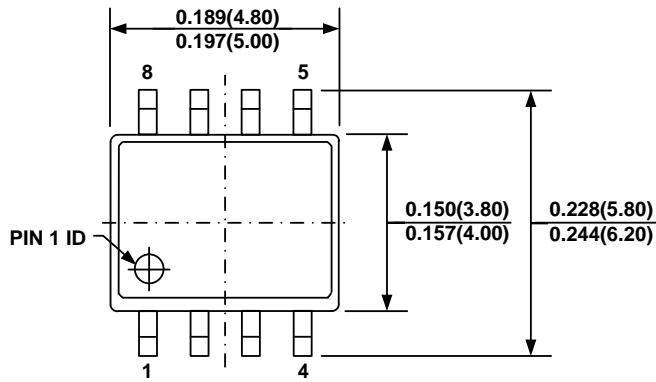

**TOP VIEW**

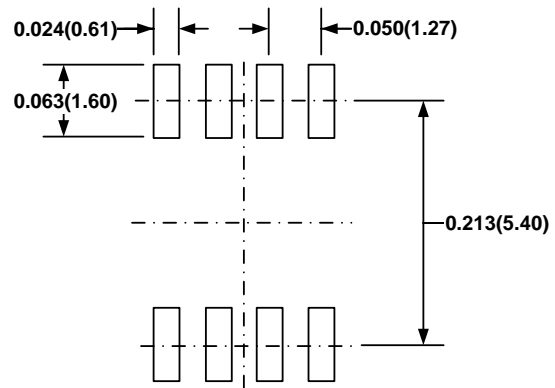

**RECOMMENDED LAND PATTERN**

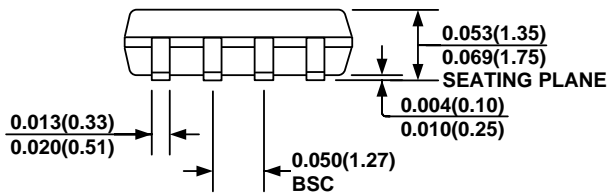

**FRONT VIEW**

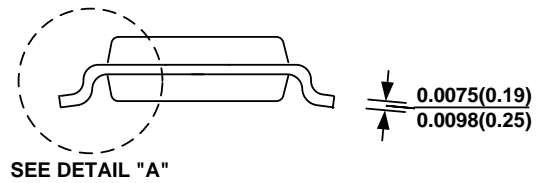

**SIDE VIEW**

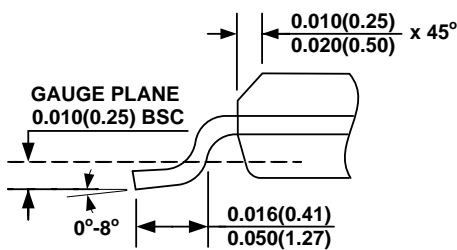

**DETAIL "A"**

**NOTE:**

- CONTROL DIMENSION IS IN INCHES. DIMENSION IN BRACKET IS IN MILLIMETERS.
- PACKAGE LENGTH DOES NOT INCLUDE MOLD FLASH, PROTRUSIONS OR GATE BURRS.
- PACKAGE WIDTH DOES NOT INCLUDE INTERLEAD FLASH OR PROTRUSIONS.
- LEAD COPLANARITY (BOTTOM OF LEADS AFTER FORMING) SHALL BE 0.004" INCHES MAX.
- DRAWING CONFORMS TO JEDEC MS-012, VARIATION AA.
- DRAWING IS NOT TO SCALE.

**NOTICE:** The information in this document is subject to change without notice. Please contact MPS for current specifications. Users should warrant and guarantee that third party Intellectual Property rights are not infringed upon when integrating MPS products into any application. MPS will not assume any legal responsibility for any said applications.